



Modern - Built-in shower set

Codice kit: 3300 UDI-140

2-way concealed thermostatic mixer with vertical tubular revolving showerhead with Flyfall and hand shower



Componenti



Concealed part

Cod: 33000802A00

2-way concealed thermostatic mixer - concealed parts

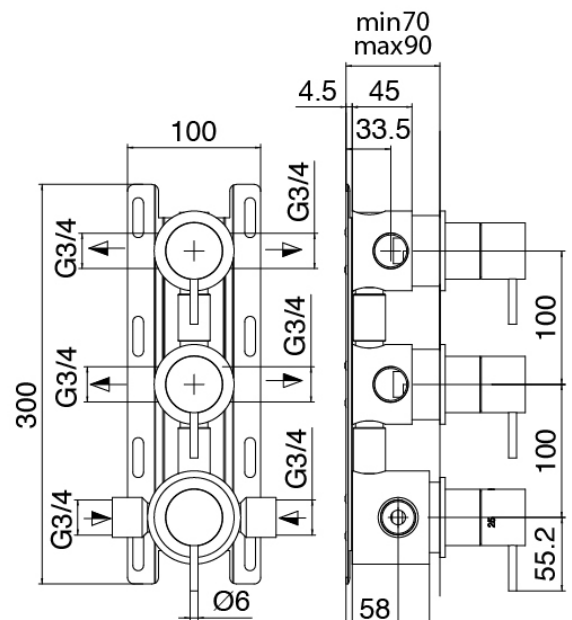



In-line concealed valves

Cod: 3300Y407AA0

In-line concealed valves - external parts

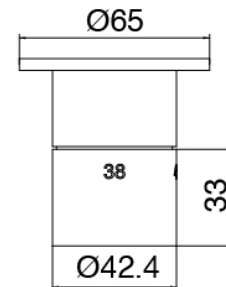
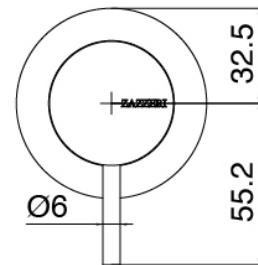
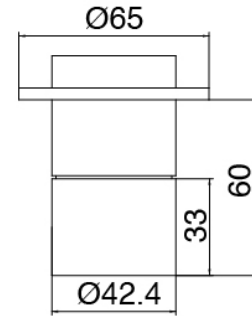
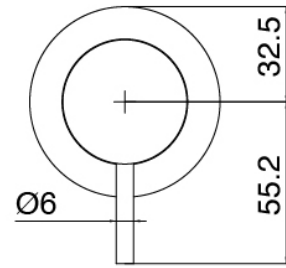

Thermostatic control

Cod: 3300T550AA0

Concealed thermostatic mixer - external parts

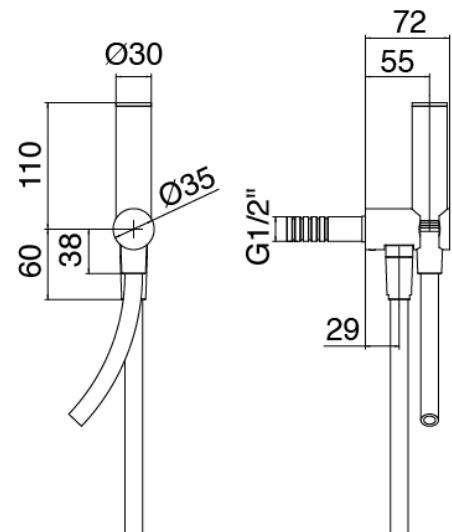

Handshower stand alone

Cod: 3300Q419A04

Handshower set, with Diam. 30mm handshower, water outlet and support

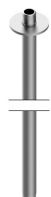

Ceiling-mounted shower head

Cod: 3300T623A00

Ceiling-mounted shower head - 700mm

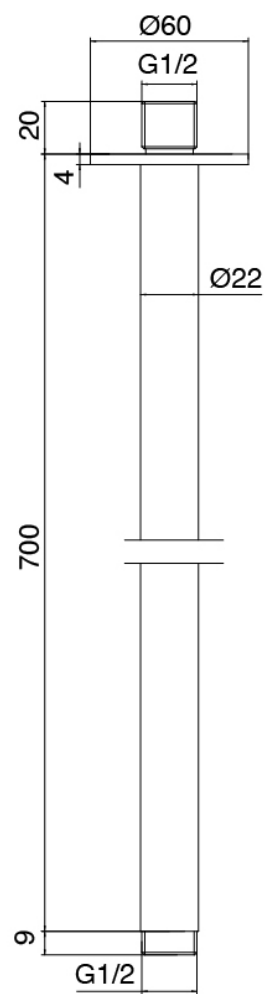



Concealed part

Cod: 3300B110A00

Ceiling-mounted - concealed part

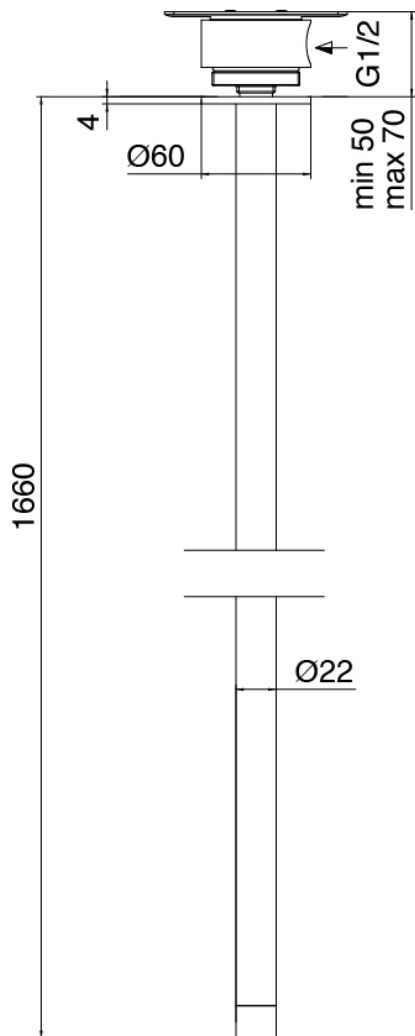



Revolving showerhead with Flyfall

Cod: 3300SO05A00

Ceiling-mounted revolving tubular showerhead with Flyfall

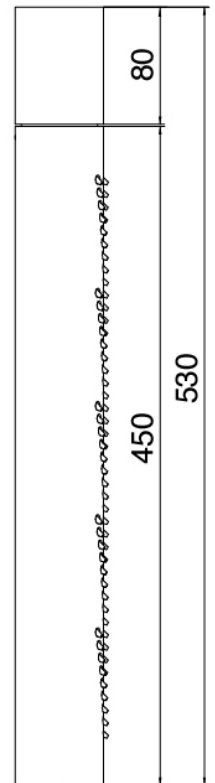
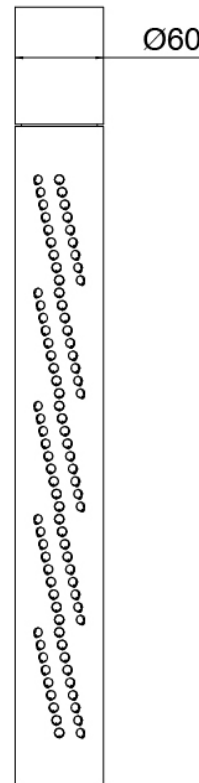

Flexible L=150mm

Cod: 3300N504A00

PVC flexible pipe for handshower - Black - L 1,5m

Finiture disponibili:

finiture speciali su richiesta salvo quantitativi minimi di ordine garantiti



brush steel

ASAS



Anthracite

APAP



Copper bronze

BPBP



Carbon

KPKP



Copper

RPRP



Cognac

CPCP



White gold

GPGP