

Modern - Sliding bar with hand shower

Codice kit: 3901 ADI-070

Sliding bar with hand shower and built-in mixer – 1 exit

Componenti



Sliding bar

Cod: 3900A417A00

Sliding bar

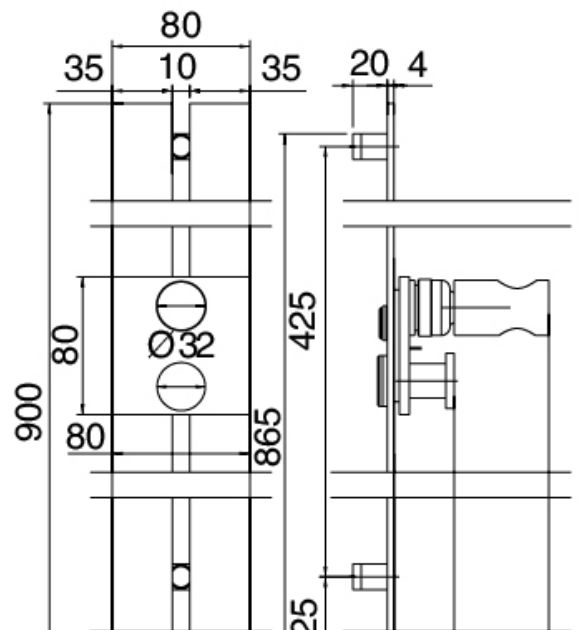



Hand shower

Cod: 3900E417A00

Anti-limescale multifunctional shower

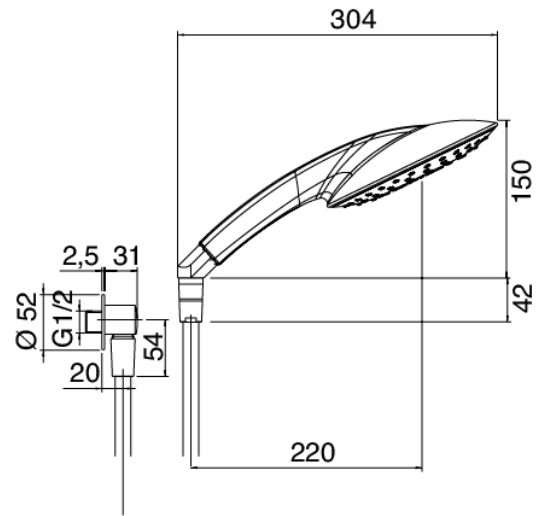

Single-lever mixer

Cod: 3901B402A00

Concealed shower mixer - external part



Concealed part

Cod: 2900A402A00

Concealed shower mixer - concealed part

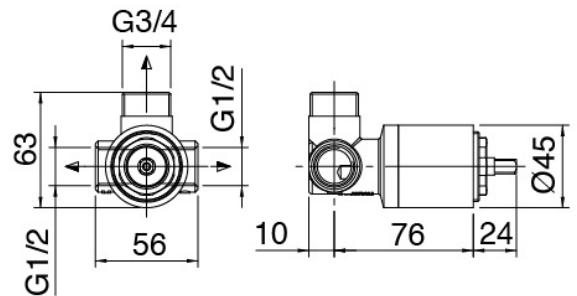

Finiture disponibili:

finiture speciali su richiesta salvo quantitativi minimi di ordine garantiti



cromo

CRCR